

102E5

*electronic mini-
programmer for
controlling hot water
and heating*

Installation & User Instructions

including Factory Replacement Units (FRU)



This product complies with the following EC Directives:

Electro-Magnetic Compatibility Directive.

(EMC) (2004/108/EC)

Low Voltage Directive.

(LVD) (2006/95/EC)



The Danfoss logo, featuring the brand name in a stylized, cursive script font.

Index

Installation

| | |
|-----------------------|-------|
| Product specification | 3 |
| Installation | 4-6 |
| Wiring | 6-9 |
| Replacement | 10-11 |

User

| | |
|---------------------------------|----|
| Your programmer | 12 |
| Setting the clock | 13 |
| Factory preset programmes | 14 |
| Setting the programme - 24 hour | 15 |
| Setting the programme - 5/2 day | 16 |
| Running the programme | 17 |
| Temporary user overrides | 18 |
| Battery backup | 19 |
| Contact details | 20 |

Installation Instructions

Please Note:

This product should only be installed by a qualified electrician or competent heating installer, and should be in accordance with the current edition of the IEEE wiring regulations.

Product specification

| Specification | |
|-----------------------------|-------------------------|
| Power supply | 230 ± 15% Vac, 50 Hz |
| Switching action | 1 x SPST, Type 1B |
| Switch rating | 264 Vac, 50/60Hz, 3(1)A |
| Timing Accuracy | ±1 min./month |
| Power Reserve | Minimum 14 days |
| Enclosure Rating | IP30 |
| Max. Ambient Temperature | 45°C |
| Dimensions, mm (W, H, D) | 103 x 137 x 48 |
| Design standard | EN 60730-2-7 |
| Control Pollution Situation | Degree 2 |
| Rated Impulse Voltage | 2.5kV |
| Ball Pressure Test | 75°C |

Specification

Installation

NB. For FRU units - go straight to point 6 below.

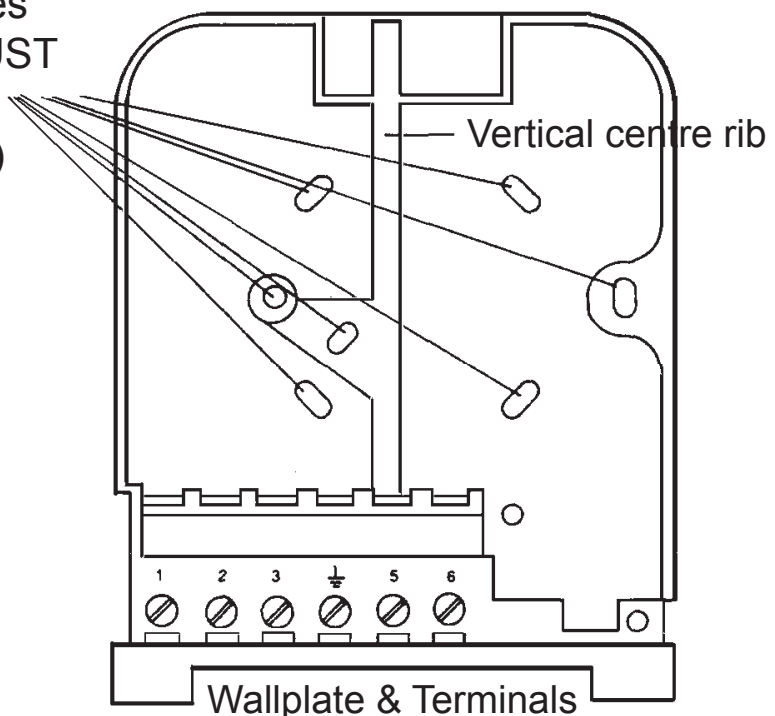

1. Loosen the fixing screw in the base of the unit to release the Wiring Cover.
2. Holding the unit face downwards, press firmly in the centre of the wallplate and slide it apart and lift it from the module.
3. Fix the wallplate and terminal block to the wall, or plaster box, as required. Ensure that the screw heads do not protrude beyond the vertical centre rib of the wallplate, or this will prevent the module correctly locating onto the wallplate.

Screw fixing holes
(screwheads MUST
NOT protrude
above centre rib)



4. Surface cables can only enter from below the unit. Cut an appropriate cable aperture in the wiring cover. If the wallplate is mounted on a plaster box, cables can enter from the rear below the terminal block.

- Electrical connections are simplified by using a Wiring Centre. However, if this is not used, the wallplate terminal identification is as shown.

| Water | Heating | COM | Mains Supply (via 3 amp fuse) | | |
|-------|---------|-----|---|---|---|
| ON | ON | |  | N | L |
| 1 | 2 | 3 |  | 5 | 6 |

If the system being controlled is 230Vac then terminals 3 and L must be linked with insulated cable capable of carrying full load current. Whilst the unit does not require an earth connection, a terminal is provided on the wallplate for earth continuity purposes.

- Referring to the wiring diagrams on page 6-9, connect the unit as shown.
- Find out from the user whether the unit is required to operate in 24-hour mode (factory preset) or weekday/weekend mode (5/2 day). To convert to 5/2 day mode remove the small two-way connector from the pins towards the left of the recess on the rear of the module, then press the **SELECT/ADVANCE/+/-** buttons all at the same time to RESET the unit.
- Ensure all dust and debris are cleared from the area. Plug the module into the wallplate by locating it onto the wallplate and, when flush with it, sliding it down, ensure the hook at the top of the wallplate engages with the slot at the back of the module.
- Before setting the programme, check the unit and circuit. Set the rocker switch to **WATER & HEATING**. Press the **SELECT** button until the bar in the display lines up with the word **ON**. Adjust the remote thermostats to check the system operates correctly.

10. Then press the **SELECT** button until the bar lines up with the word **OFF** and check the system does not operate.
11. Set the rocker switch to **WATER ONLY**. Press the **SELECT** button until the bar in the display lines up with the word **ON** and check that the water circuit only operates.
12. When the circuit check has been completed, replace the wiring cover and tighten the fixing screw. Cut any cable aperture in the wiring cover which may be necessary to accommodate surface mounted cables.
13. Finally set time of day and programmes required, noting that the unit is supplied with a pre-set programme, as stated on Page 14.

Wiring

Wiring

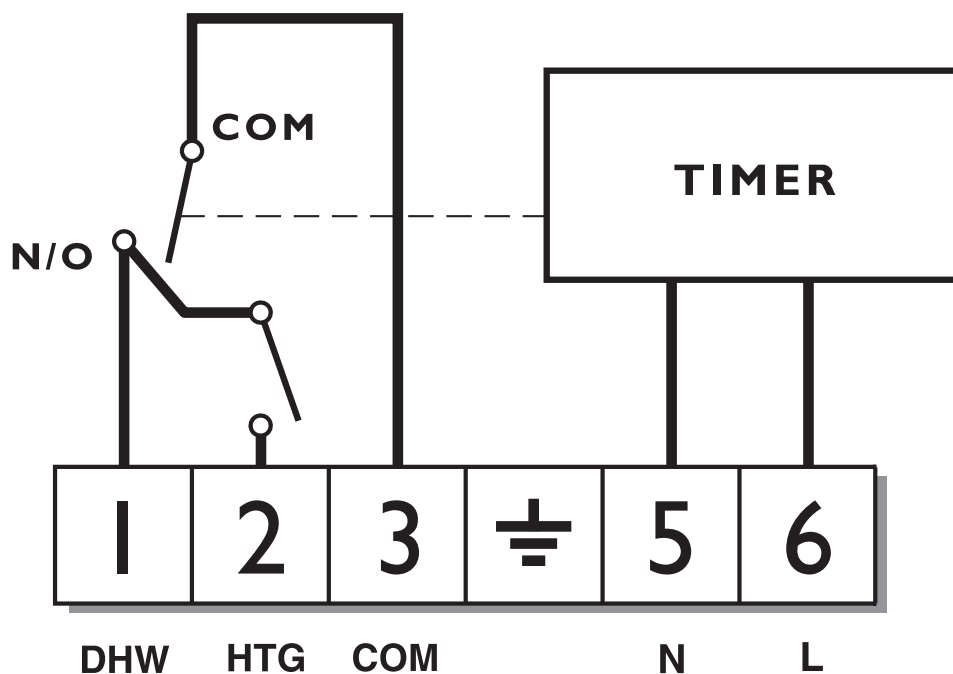

102, 102E5, 102E7

Typical Gravity DHW with Pumped Heating

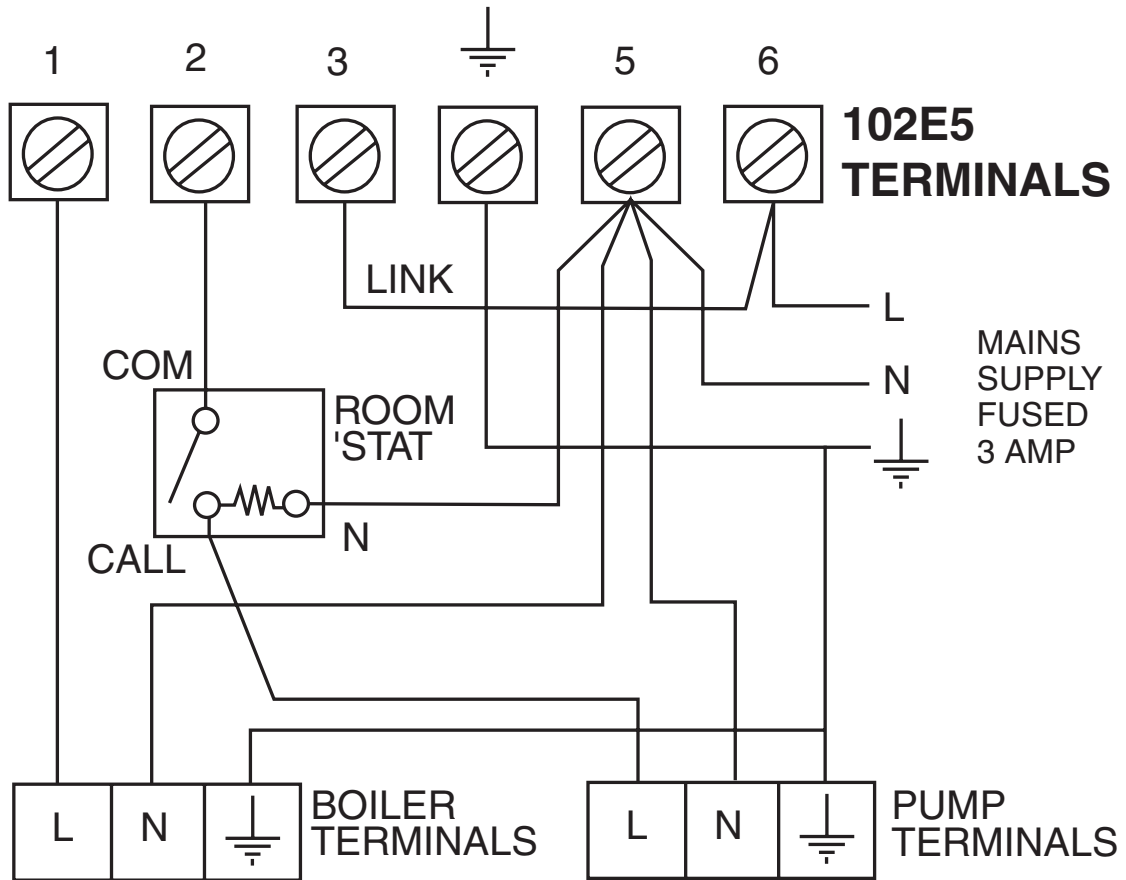

Typical domestic gas or oil-fired central heating system with gravity hot water and pumped heating. (If a room thermostat is not used, wire pump live directly to terminal 2 of the 102E5).

Typical Heating and Hot Water control system using 3-port mid-position valve

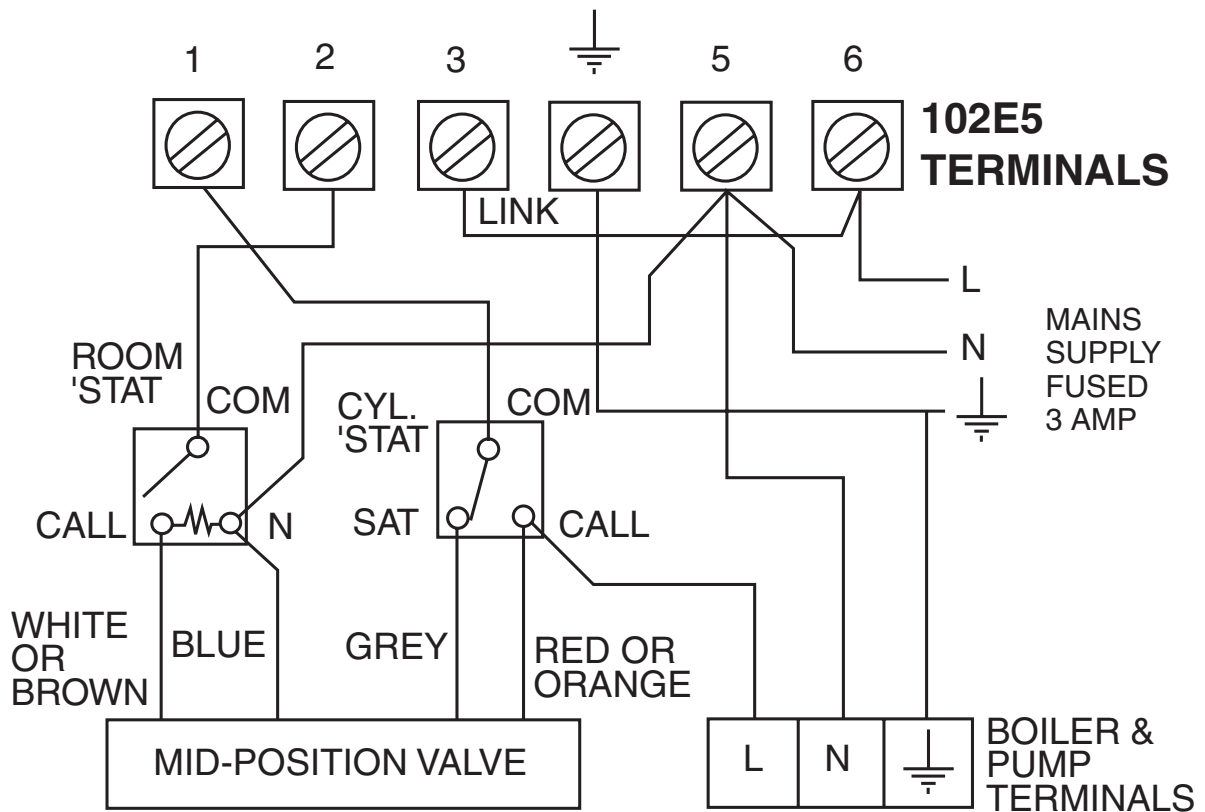

Wiring





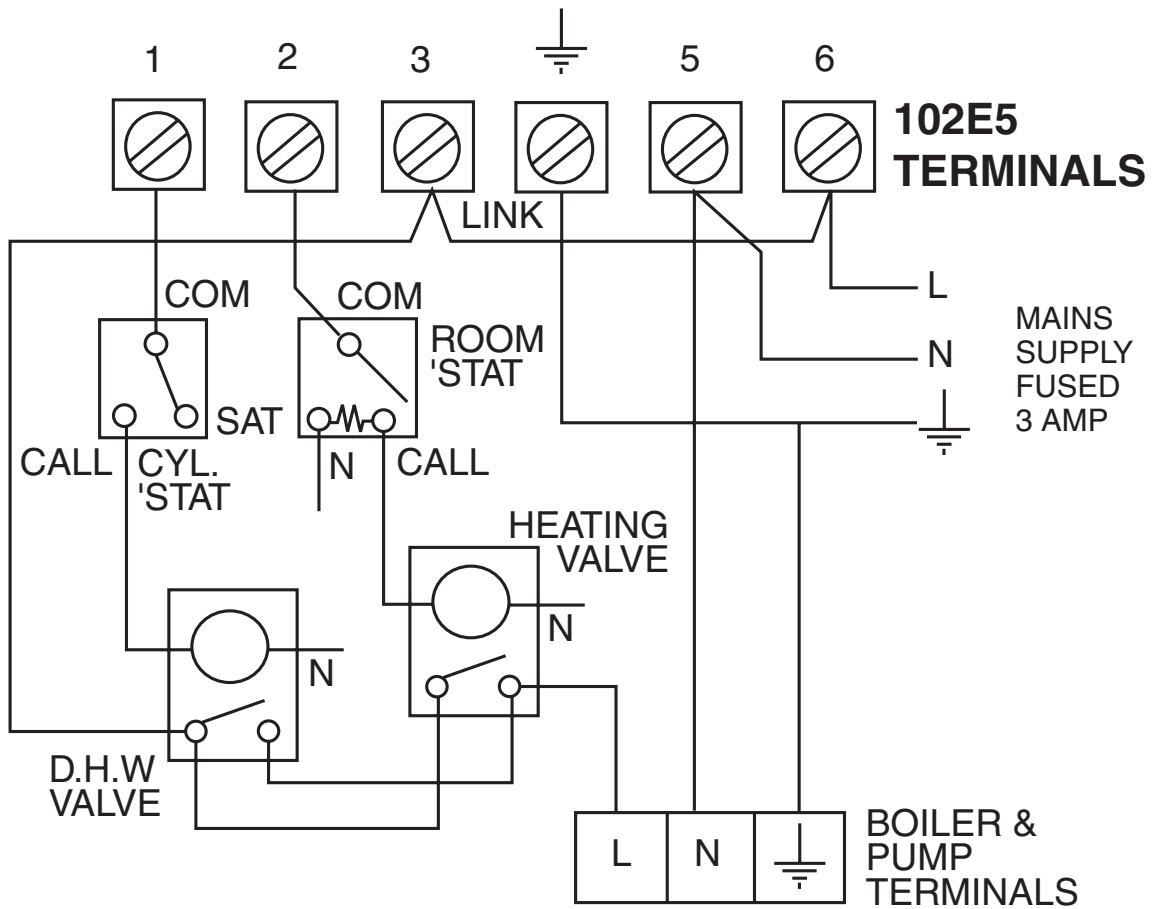





The above control system is available as the Danfoss Randall 102E5 HEATSHARE pack, which also includes the TW room thermostat, AT cylinder thermostat, HS3 mid-position valve and a WB12 wiring box.

Typical Heating and Hot Water control system using 2-port zone valves



The above control system is available as the Danfoss Randall 102E5 HEATPLAN pack, which also includes the TW room thermostat, AT cylinder thermostat, two 22mm HPP zone valves and a WB12 wiring box.

Replacement

| DANFOSS RANDALL 102E5 | Water ON | Heating ON | COM | MAINS SUPPLY (via 3 amp fuse) | | | An additional terminal block is required where these discon- nected leads (or pairs of leads) should be terminated | | |
|--------------------------------------|---------------|------------------|-----|---|-------|-------|---|---|---|
| | | | |  | 5 (N) | 6 (L) | A | B | C |
| | 1 | 2 | 3 |  | 5 (N) | 6 (L) | A | B | C |
| RANDALL 102, 102E, 102E7 | 1 | 2 | 3 |  | 5 | 6 | | | |
| RANDALL 3020P, 3060 | 4 | 2 | - |  | 1,7 | 6 | 3 | 5 | |
| RANDALL MKII R6 | 4 | 5 | - |  | 3 | 1,2 | 6 | 7 | |
| HORSTMANN CORAL 423 & 424 | Boiler (8) | Air 'Stat (8) | - |  | 2,3 | 1 | 4,7 | 5 | 6 |
| HORSTMANN DIAMOND 423 | 2 | 4 | - |  | N | L,1,3 | 5 | 6 | |
| HORSTMANN DIAMOND 424 | 2 | 4 | - |  | N | L,1,3 | 5 | | 6 |
| POTTERTON 423 | 2 | 4 | - |  | N | L,1,3 | 5 | 6 | |
| SANGAMO S409 F1 & F4 | 2 | 5 | - |  | N,1,3 | L | 4,6 | | |
| SANGAMO (Early model) S410 Form 4 | 1,3 | 4 | - |  | N,2 | L | | | |

| | | | | | | | | | |
|--|---|-----|---|---|-------|------|-------|---|--|
| SMITHS IND. CENTROLLER 100 | 3 | 2 | - | ⊥ | N | L | 1 | 4 | |
| SMITHS IND. CENTROLLER 60 | 5 | 4 | - | ⊥ | 1 | 2 | 3 | | |
| SMITHS IND. CENTROLLER 10 | 3 | 2 | - | ⊥ | N | L | 1,4 | | |
| SMITHS IND. CENTROLLER 70 | 5 | 4 | - | ⊥ | 1 | 2 | 3 | 6 | |
| SWITCHMASTER 320, 350 | 3 | 1 | - | ⊥ | N | 4,L | 2 | | |
| SWITCHMASTER 600 | 3 | 1 | - | ⊥ | N | L | 2 | 4 | |
| VENNER VENOTROL | V | S,F | - | ⊥ | N,A,M | L,L1 | T,P | 0 | |
| VENNER VENOTROL 80 (Air 'Stat) | 2 | A/S | - | ⊥ | N,1,3 | L | A/S,5 | | |
| VENNER VENOTROL 80 (Air 'Stat Linked) | 2 | 5 | - | ⊥ | N,1,3 | L | | | |

User Instructions

Your programmer

Your 102E5 mini-programmer allows you to switch your heating and hot water on and off at times that suit you.

The 102E5 can provide 3 ON periods and 3 OFF periods each day and can offer either 24 hour control (same programme for each day of the week) or 5/2 day control (one set of programmes for weekdays and a different set for weekends).

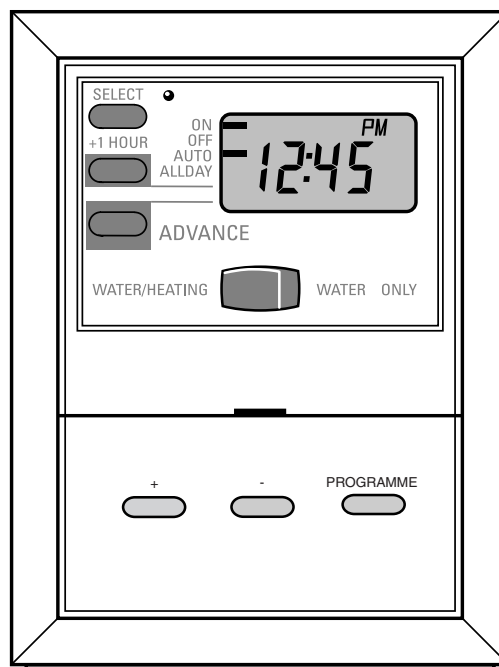

Before you start

- ❑ Open the flap on the front of the unit.
- ❑ Press all four buttons (**SELECT / ADVANCE / + / -**) at the same time

This will reset the unit, reinstate the preset programmes and set the time to 12:00pm on Monday.

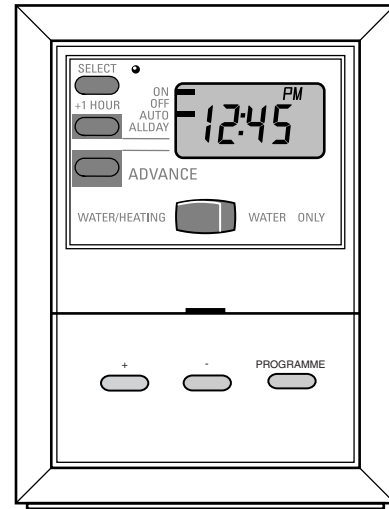

Setting the clock

- ❑ Press **PROGRAMME** once
- ❑ Use **+** and **-** buttons to set the correct time (press and hold to change in 10 min increments).
- ❑ When time is correct press **PROGRAMME** again.

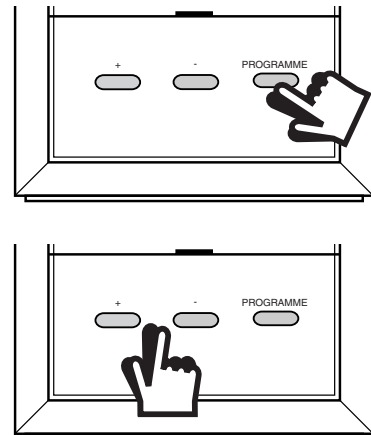

In **24 hour mode** this will take you straight to programming mode, where you can select your own ON and OFF times.

In **5/2 day mode** this first will allow you to programme the correct **DAY**. To do this:

- ❑ use the **+** or **-** buttons to select the correct day
- ❑ press **PROGRAMME** again to enter programming mode

Factory Presets

The unit is supplied with the following preset programme which will be active after the unit has been reset.

| | Mon-Fri or All days in 24hr mode | Sat-Sun* (5/2day mode only*) |
|---------|----------------------------------|------------------------------|
| 1st ON | 6.30am | 7.30am |
| 1st OFF | 8.30am | 10.00am |
| 2nd ON | 12.00pm | 12.00pm |
| 2nd OFF | 12.00pm | 12.00pm |
| 3rd ON | 5.00pm | 5.00pm |
| 3rd OFF | 10.30pm | 10.30pm |

Factory preset programmes

NB. 2nd ON and 2nd OFF are set to the same time. These 2 times are ignored by the programme therefore the heating will just come on once in the morning and once in the evening. If you want the heating to come on in the middle of the day set the 2nd ON and 2nd OFF to the times you require.

Accepting the preset times

If you are happy to use the settings above, you don't need to do anything else.

To accept the presets press the **PROGRAMME** button until the colon in the display begins to flash.

Your unit is now in **RUN** mode.

Programming event times in 24 hour mode

You can programme your heating and hot water to come on and go off up to 3 times each day, to suit your requirements.

- ❑ Press **PROGRAMME** until 1 (Event 1) shows along the top of the display.
- ❑ Use the **+** and **-** buttons to set the time you want your system to first come on in the morning
- ❑ Press **PROGRAMME** again to move to the next step (Event 2)
- ❑ Use the **+** and **-** buttons to set the time you want your system to first go off.
- ❑ Continue using the **PROGRAMME** and **+/-** buttons in this way to set the ON/OFF times for events 3-6 (2nd ON/OFF & 3rd ON/OFF).

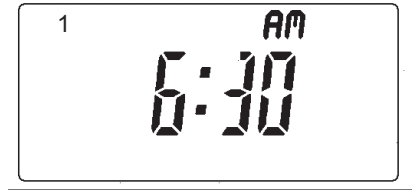

NB. It is not possible to programme times out of sequence.

If you do not press a button at all for 3 or 4 minutes the unit will automatically return to RUN mode.

Programming event times in 5/2 day mode

You can programme your heating and hot water to come on and go off up to 3 times each day, to suit your requirements, with one set of programmes for weekdays and a different set of programmes for the weekend.

Weekdays (MOTUWETHFR)

- Press **PROGRAMME** until 1 (Event 1) shows along the top of the display and **MOTUWETHFR** shows along the bottom.
- Use the **+** and **-** buttons to set the time you want your system to first come on in the morning
- Press **PROGRAMME** again to move to Event 2
- Use the **+** and **-** buttons to set the time you want your system to first go off.
- Continue using the **PROGRAMME** and **+/-** buttons in this way to set the ON/OFF times for events 3-6 for weekdays.

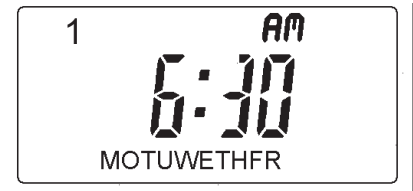

Weekend (SASU)

- Press **PROGRAMME** again until 1 (Event 1) shows along the top of the display and **SASU** shows along the bottom of the display.
- Use the **PROGRAMME** and **+/-** buttons to set the ON/OFF times for the weekend.

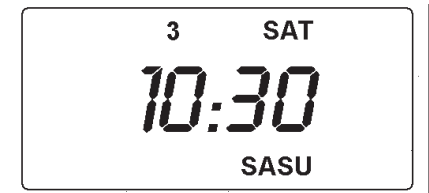

If at any time you wish to return to the factory preset programme, press **SELECT / ADVANCE / + / -** buttons together at the same time to reset the unit.

Running your programme

The 102E5 will either control your hot water and heating together, or just your hot water (i.e. during the summer, when heating is no longer required).

To make your selection use the rocker switch under the LCD display to select either **WATER/HEATING** or **WATER ONLY**



To run the central heating and/or hot water programme press the **SELECT** button.

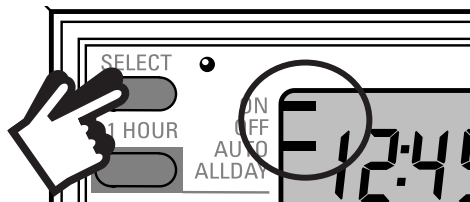

As you press **SELECT** a bar on the display will move between **ON**, **OFF**, **ALLDAY** and **AUTO**

- **ON** = the hot water/heating will remain on constantly
- **OFF** = the hot water/heating will not come on
- **AUTO** = the hot water/heating will come on and go off according to the programmed times
- **ALLDAY** = the unit will come on at the first programmed ON and will remain on until the last programmed OFF

Select the option you require, depending on your circumstances, time of year, etc.

Temporary User Overrides

Sometimes you may need to change the way you use your heating temporarily, i.e due to unusually cold weather. The 102E5 has two convenient overrides which can be selected without affecting the set programme.

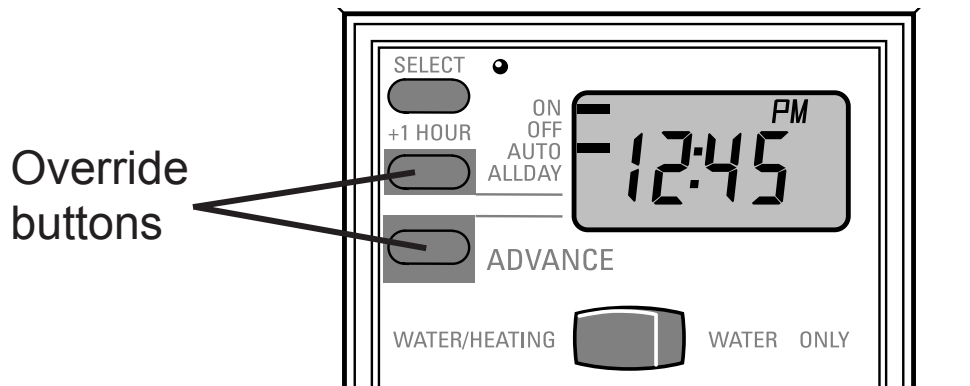

+1HOUR

- ❑ Press **+1HOUR** once if you need **an extra hour of operation** (a red light will come on).
If the system is off it will come on for an hour. If it is already on it will add an extra hour so the system stays on for an extra hour.
- ❑ To cancel the override press +1HOUR again (red light will go off).

ADVANCE (does not work when unit set to OFF)

- ❑ Press the **ADVANCE** button once to **advance to the next programmed event** (a red light will come on).
If the system is on it will go off. If it is off it will come on. The set programme will resume at the next programmed ON/OFF time
- ❑ To cancel the override press ADVANCE again (red light will go off).

Battery backup

In the event of a power cut, the built-in lithium battery will keep your time and programme settings for up to 15 days.

After 15 days without mains power the unit will switch off and two dots will show in the display. However all your programmed on/off times will be remembered.

When the mains power is restored, the unit will need to be reactivated by pressing the **PROGRAMME** button, and the time and day will need to be set (see page 13).

Still having problems?

Call your local heating engineer:

Name:

Tel:

Visit our website:

www.danfoss-randall.co.uk

Email our technical department:

drl_technical@danfoss.com

Call our technical department

0845 121 7505

(8.45-5.15 Mon-Thurs, 8.45-4.45 Fri)

For a large print version of these instructions please contact the Marketing Services Department on 0845 121 7400.



Danfoss Randall Ltd

Amphill Road

Bedford

MK42 9ER

Tel: 01234 364621

Fax: 01234 219705

